



## Accessories

### 34050402 - M12, 4pin D-Coded, Male



#### Characteristics of Head 1

Standards/Regulations	M12 Connector
Coding	D - Standard
Gender	Male
Number of Positions	04
Contact Surface Material	Au
Housing Material	Zinc Die-cast, Nickel Plated
Knurls Material	Zinc die-cast, nickel-plated
Contact Connection Method	Screw Connection
Degree of Protection	IP67
Fixing Torque	0.4 Nm (M12 Connector)
Cable Diameter Range	4 - 6 mm
Conductor AWG Range	24 - 18
Cross Section Range	0.25 - 0.75 mm <sup>2</sup>

#### General Data

Ordering Code	34050402 - CTR-M12S-M04D-NPSC
Weight	50 g
Operating Temperature	-40 °C / -40° F to 85 °C / 185° F

Data Sheet

Printed at 3-06-2019 05:06



## Pin Assignment

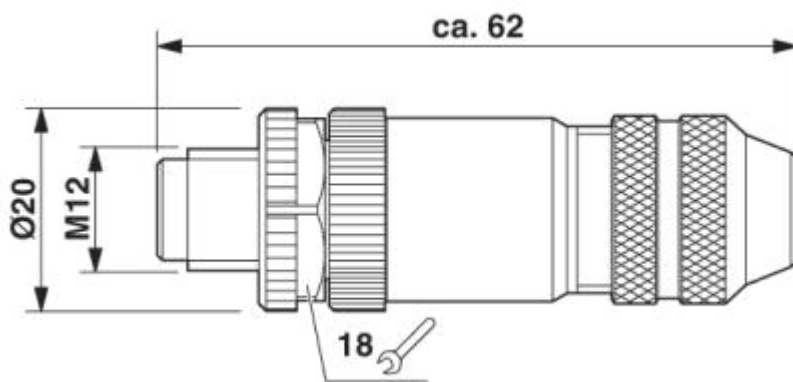
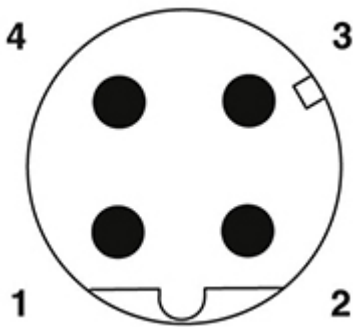

## Contact



Contact Us

All dimension in [inch] mm. This drawing and the information contained is for general presentation purposes only. Please refer to the "Download" section for detailed technical drawings. © FRABA B.V., All rights reserved. We do not assume responsibility for technical inaccuracies or omissions. Specifications are subject to change without notice.